

Schnitt

T=900

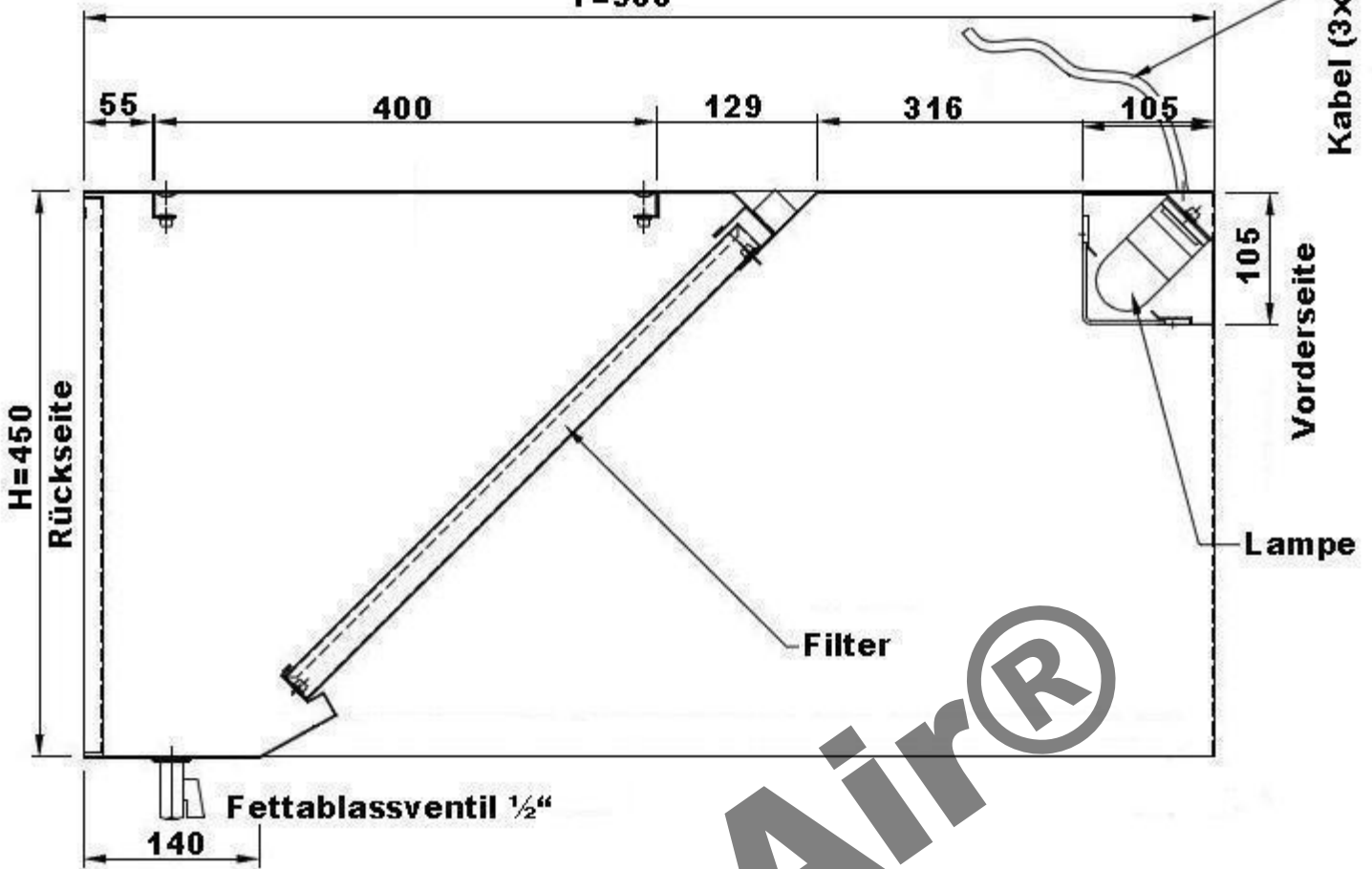

Draufsicht

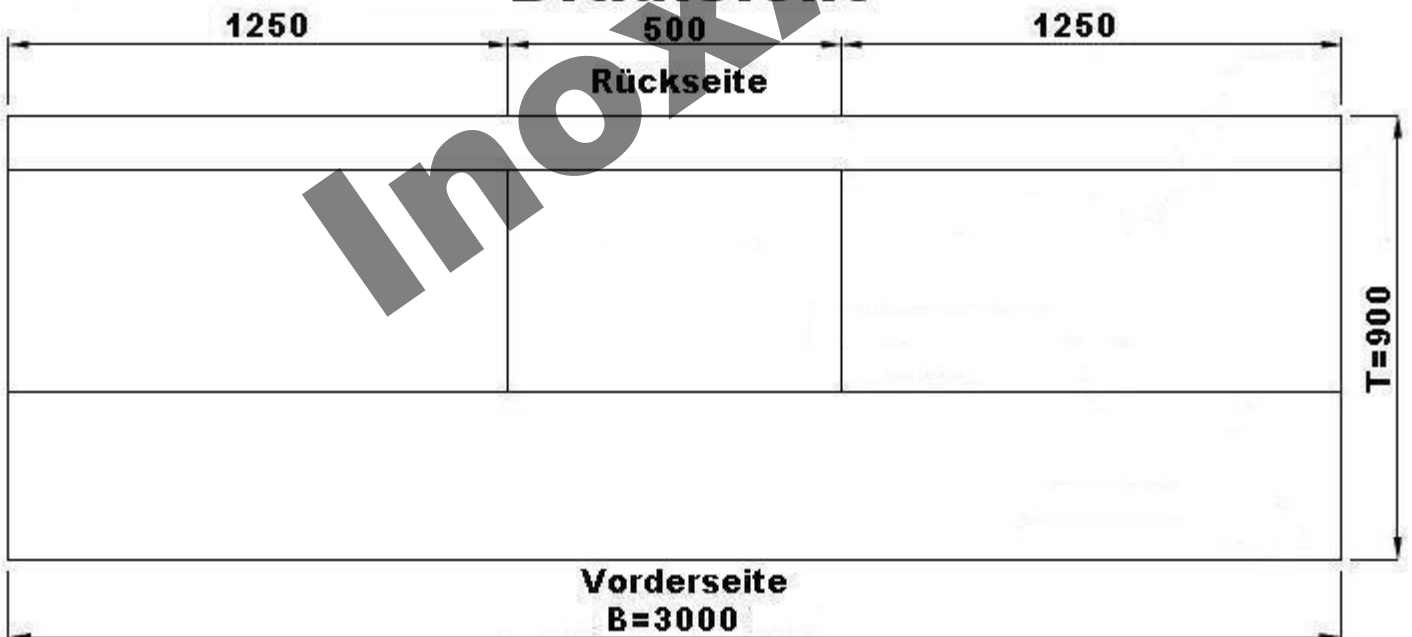

InoxAir®

InoxAir

		Maßstab:	Zeichg.Nr.:	WHK0930
		Werkstoff:		
		1.4016		
	Datum	Name	Benennung:	
Bearb.:	05.07.11		Wandhaube Kastenform 90x300cm	
Gepr.:				
Norm:				