

Schnitt

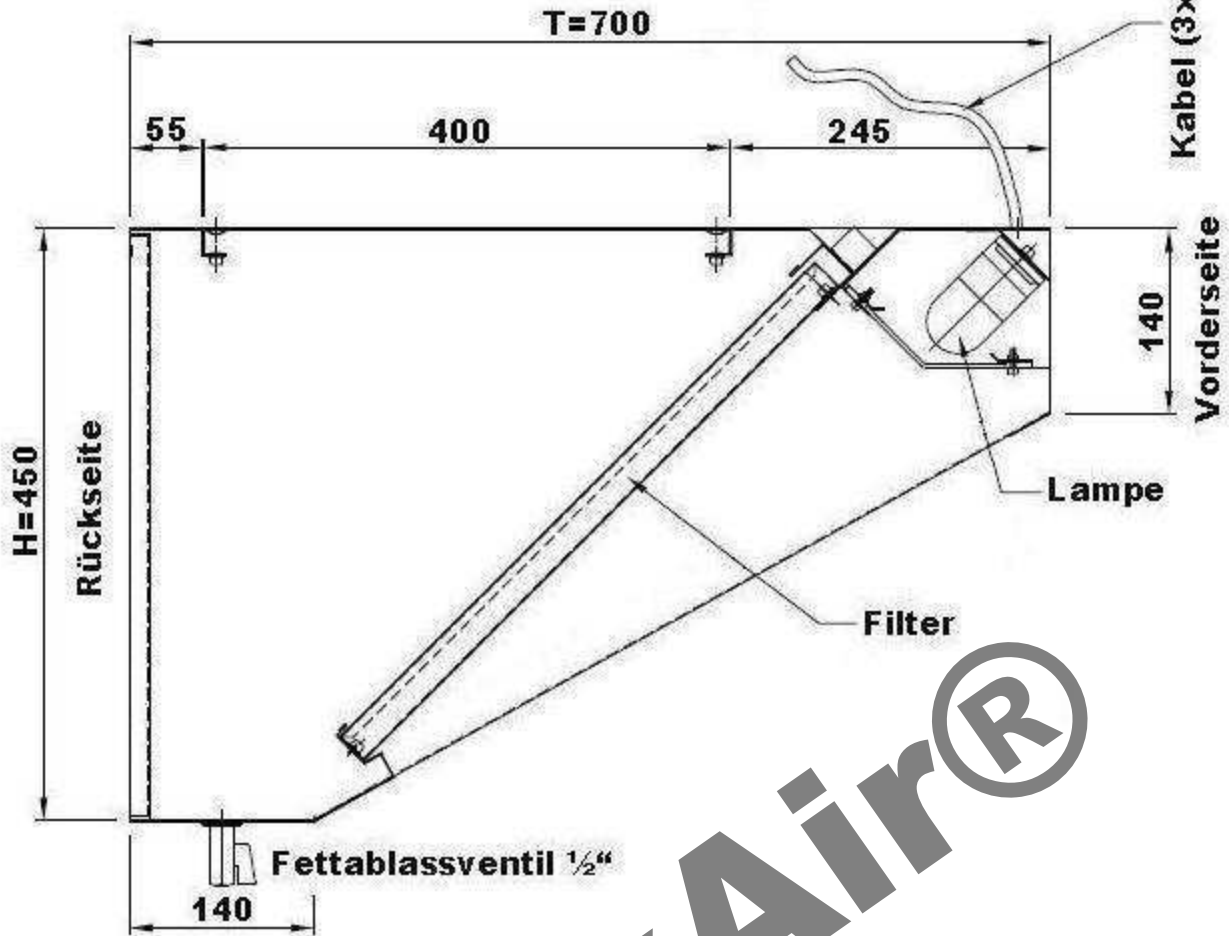

Draufsicht

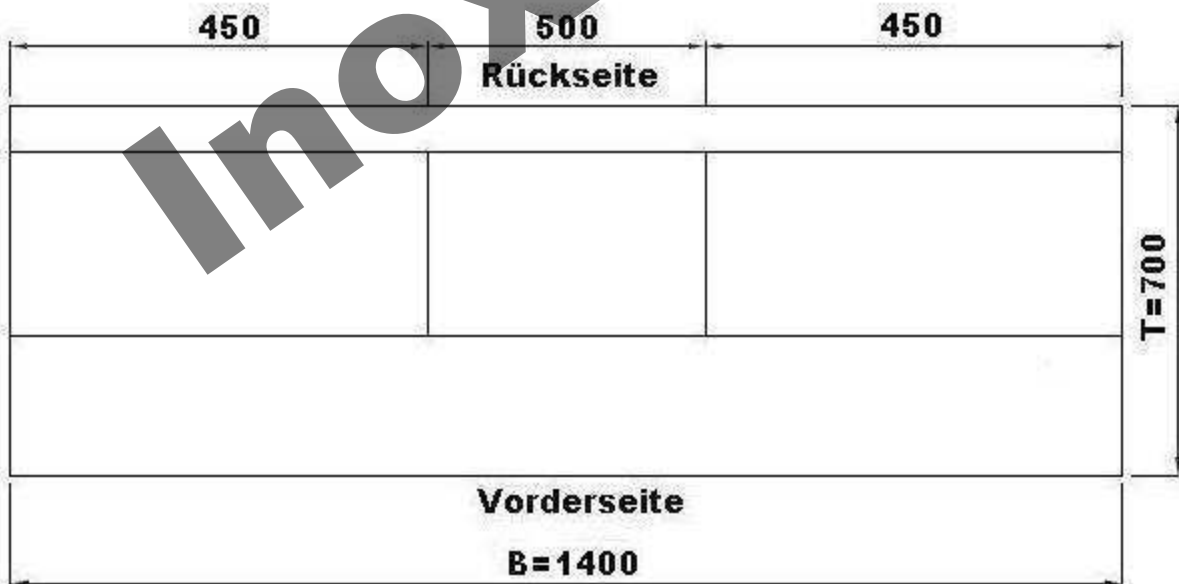

InoxAir®

InoxAir

		Maßstab:	Zeichn.Nr.:	WSV0714VDI
		Werkstoff:		
		1.4301		
	Datum	Name	Benennung:	
Bearb.:	05.07.11		Wandhaube Schrägform 70x140x45cm	
Gepr.:				
Norm:				