

# Schnitt

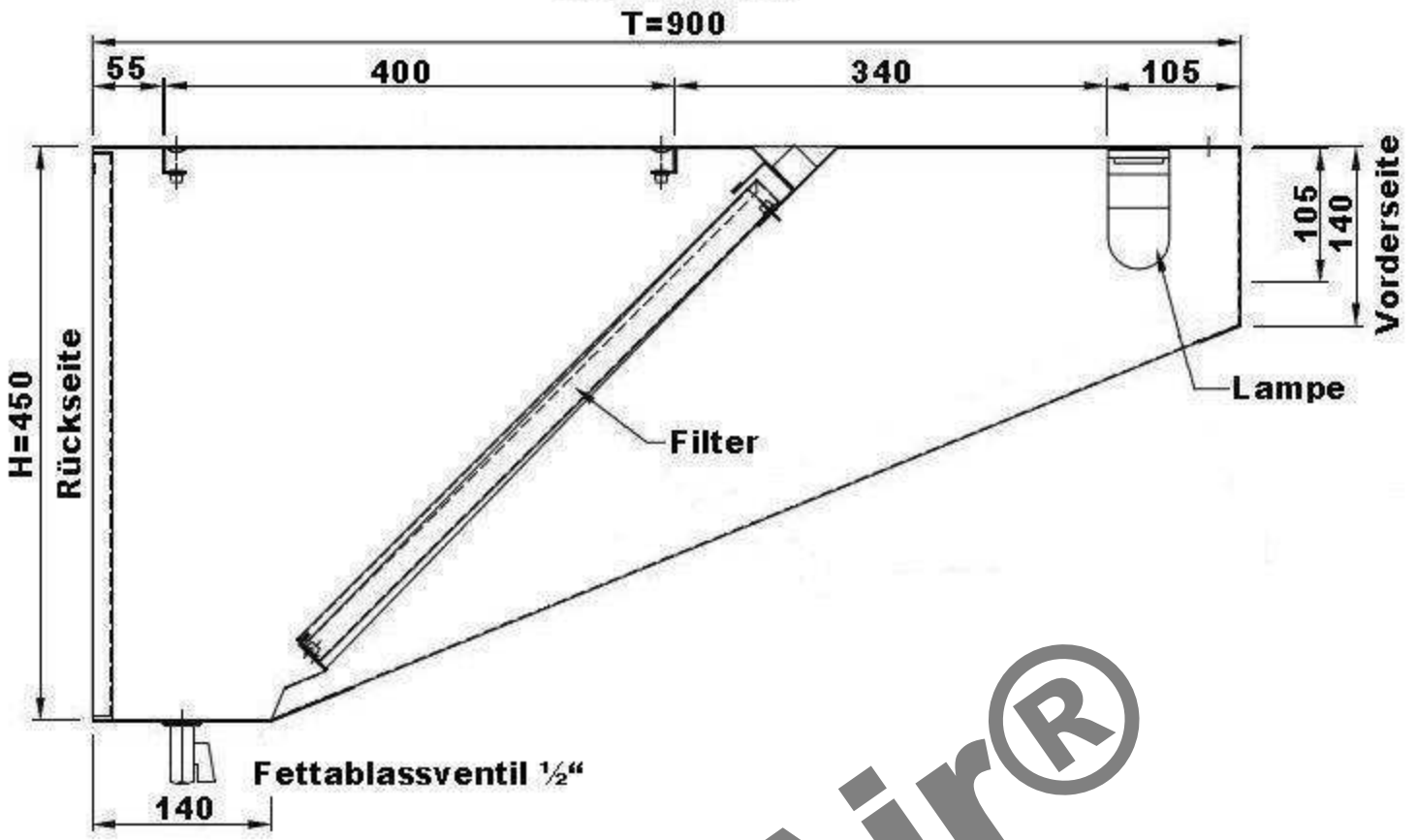

# Draufsicht



InoxAir®

InoxAir

			Maßstab:	Zeichn.Nr.:	WHE0938
			Werkstoff:	1.4016	
	Datum	Name	Benennung:		
Bearb.:	05.07.11		Wandhaube 90x380cm		
Gepr.:					
Norm:					