

# Schnitt

T=700

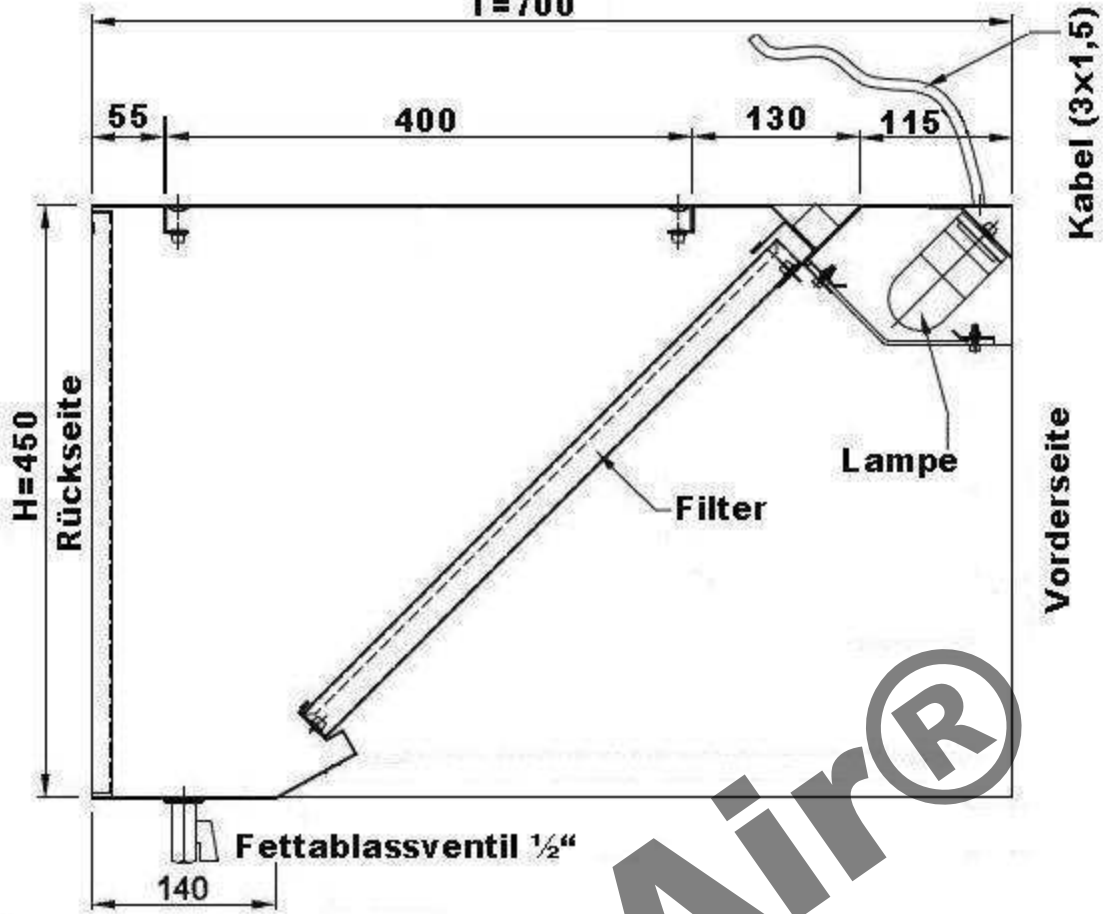

# Draufsicht



InoxAir®

InoxAir

		Maßstab:	Zeichn.Nr.:	WKV0734VDI
		Werkstoff:	1.4301	
	Datum	Name	Benennung:	
Bearb.:	05.07.11		Wandhaube Kastenform 70x340x45cm	
Gepr.:				
Norm:				