

Schnitt

T=700

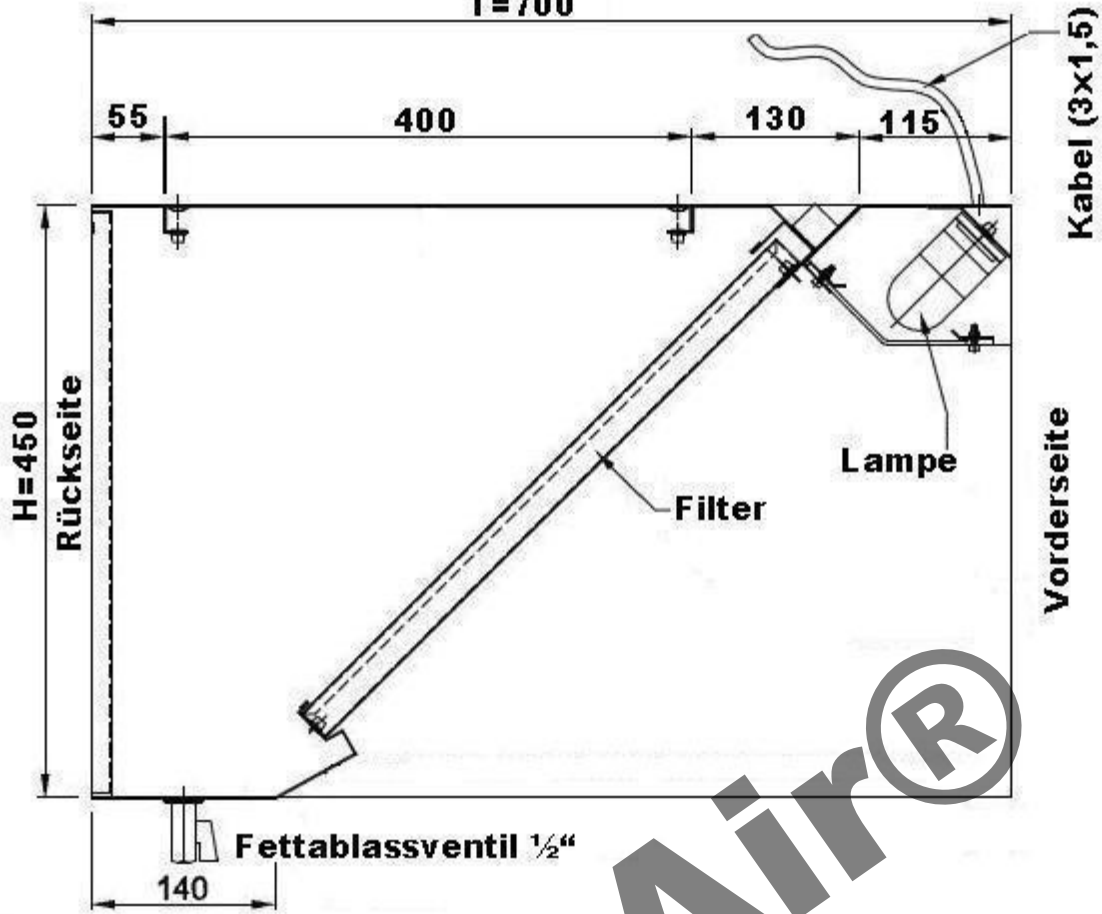

Draufsicht



InoxAir®

InoxAir

			Maßstab:	Zeichn.Nr.:	WHK0716
			Werkstoff:	1.4016	
	Datum	Name	Benennung:		
Bearb.:	05.07.11		Wandhaube Kastenform 70x160cm		
Gepr.:					
Norm:					