

Schnitt

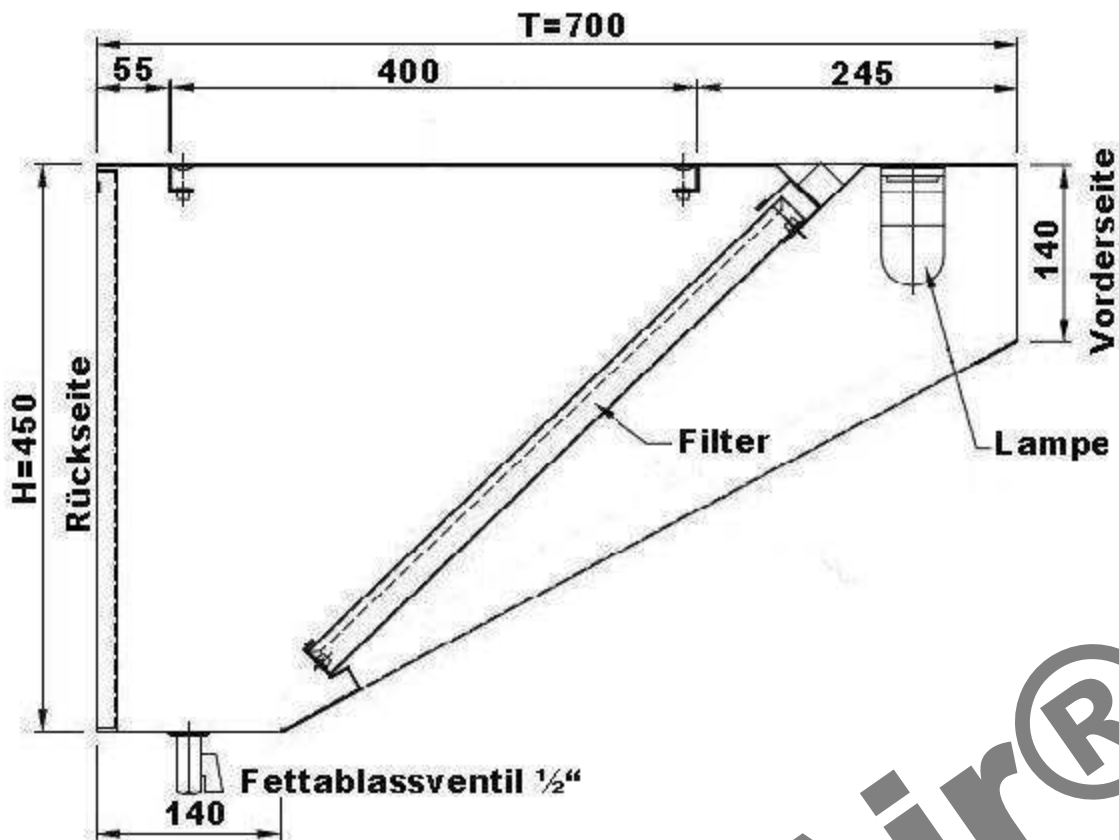

Draufsicht



InoxAir®

InoxAir			Maßstab:	Zeichn.Nr.:	WHE0740	
			Werkstoff:			1.4016
		Datum	Name	Benennung:		
	Bearb.:	05.07.11		Wandhaube 70x400cm		
	Gepr.:					
	Norm:					